

KATALÓG-CATALOG-KATALOG



97668 Heľpa 1108
Slovakia - Slowakai
Tel./fax: 048/6186511,
www.majk.sk, majk@majk.sk

MAJK

GUMA – PLASTY – SILIKÓN
RUBBER – PLASTIC – SILICONE

v: 04.01-21



EXTRÚZIA
EXTRUSION
EXTRUDIERTERTE

VYREZÁVANIE
CUTTING
GESCHNITZTE



LISOVANIE
PRESSING
GEPRESSTE

3D-TLAČ
3D-PRINTING
3D-DRUCKEN





Popis a použitie - vyrábajú sa rôznych tvarov a podľa tohto prevedenia ich je možné použiť ako napr. tesnenia za pracovné dosky, na kuchynské linky, podlahové lišty (sokle), hrany na schody, bužírky rôznych rozmerov, hadice a iné špeciálne profily, ktoré sa používajú do rôznych konštrukčných (stavebných) častí, ale aj v domácnosti, v záhradníctve, nábytkárstve a v rôznych iných odvetviach priemyslu.

Vlastnosti - profily výrobné z mäkkého PVC odolávajú bežným poveternostným vplyvom a teplotám od -15 °C to + 70 °C bez zmeny svojich úžitkových vlastností, avšak pri dlhotrvajúcom slnečnom pôsobení dochádza k ich pomalému starnutiu. Ponúkame tiež modifikové PVC s vysokou odolnosť voči UV, výbornými vlastnosťami trvalej deformácie, odolnosťou voči rôznym čistiacim chemikáliám.

Prevedenia - sú vyrábané v niekoľkých základných tvaroch, ako štvorec, obdĺžnik, kruhové tesnenie, medzikružia a rôzne špeciálne tvary. Tesnenia je možné tiež vyrobiť ako samolepiace.

Materiálový základ - pri výrobe sú použité rôzne druhy PVC granulátu mernej hmotnosti 1,2 -1,5 g/cm³ a tvrdosti od 50 do 90°ShA. Vlastnosti jednotlivých granulátov sa líšia v závislosti od výrobcu.

Tolerancie - všetky naše vytlačované výrobky spĺňajú tolerancie podľa ISO 3302 - E1-E3

Description and use - they are produced in various shapes and according to a design they can be used as e.g. gaskets for work desks, kitchen units, skirting boards, stair edges, insulating tubes of different sizes, hoses, and other special profiles that are used in various structural (building) parts, households, gardening, furniture, and various other industries.

Properties - profiles made of softened PVC are resistant to standard weather conditions and temperatures from -15 °C to + 70 °C without changing the performance properties, however, with prolonged sun exposure, there is a slow aging process. We also offer modified PVC with high UV resistance, excellent properties of permanent deformation, resistance to various cleaning chemicals.

Design - they are produced in several basic shapes, such as square, rectangle, circular gasket, intermediate ring, and various specific shapes. Gaskets can also be made as self-adhesive.

Material basis - various types of PVC granulate with a specific weight of 1.2 -1.5 g / cm³ and a hardness range from 50 to 90 °ShA are used in the production. The properties of the individual granules vary depending on the manufacturer.

Tolerances - all our extruded products meet the tolerances according to ISO 3302 - E1-E3

Beschreibung und Benutzung - sie werden in verschiedenen Formen hergestellt und je nach der Ausführung können sie benutzt werden z. Bsp. als Dichtungen für Arbeitsplatten, Küchenarbeitsplatten, Fußbodenleisten (Sockel), Treppenkanten, Bougieerohre verschiedener Abmessungen, Schläuche und andere Spezialprofile, die in verschiedenen Konstruktionsteilen (Bauteilen), aber auch im Haushalt, im Gartenbau, in der Möbelindustrie und in verschiedenen anderen Industriezweigen benutzt werden.

Eigenschaften - die aus Weich-PVC hergestellten Profile halten den üblichen Witterungseinflüssen und Temperaturen von -15 °C bis + 70 °C stand, ohne ihre Nutzeigenschaften zu ändern, bei der langfristigen Sonneneinwirkung kommt es jedoch zu ihrer langsamen Alterung. Wir bieten auch modifiziertes PVC mit hoher UV-Beständigkeit, ausgezeichneten Eigenschaften der Dauerverformung und mit Beständigkeit gegen verschiedene Reinigungschemikalien an.

Ausführungen - sie werden in einigen Grundformen hergestellt als Quadrat, Rechteck, Runddichtung, Kreisring und verschiedene Spezialformen. Die Dichtungen können auch als selbstklebend hergestellt werden.

Materialgrundlage - bei der Herstellung sind verschiedene PVC-Granulate mit spezifischem Gewicht von 1,2 - 1,5 g/cm³ und mit der Härte von 50 bis 90°ShA benutzt. Die Eigenschaften der einzelnen Granulate unterscheiden sich je nach dem Hersteller.

Toleranzen - Alle unsere extrudierten Produkte erfüllen die Toleranzen gemäß ISO 3302 - E1-E3.

Profily štvorcového prierezu

Číslo profilu	Rozmer A x A
710007/XX0000	7 x 7
710023/XX0000	23 x 23

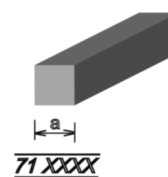

Profily obdĺžnikového prierezu

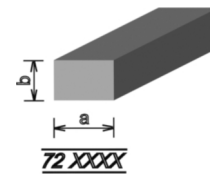

Číslo profilu	Rozmer A x B
7202.808/XX0000	8 x 2,8
7202.815/XX0000	15 x 2,8
720220/XX0000	20 x 2
720257/XX0000	57 x 2
720325/XX0000	25 x 3
720330/XX0000	30 x 3
720380/XX0000	80 x 3
720510/XX0000	10 x 5
720512/XX0000	12 x 5
720514/XX0000	14 x 5
720555/XX0000	55 x 5
720665/XX0000	65 x 6
720812/XX0000	12 x 8
721215/XX0000	15 x 12
721225/XX0000	25 x 12
721511/XX0000	11 x 15
721530/XX0000	30 x 15
722025/XX0000	25 x 20
722030/000000	30 x 20

Profily kruhového prierezu

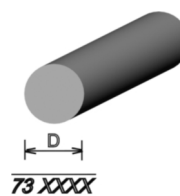

Číslo profilu	Rozmer D
730003/XX0000	3
730004/XX0000	4
730005/XX0000	5
730006/XX0000	6
730008/XX0000	8
730009/XX0000	9
730010/XX0000	10
730012/XX0000	12
730018/XX0000	18

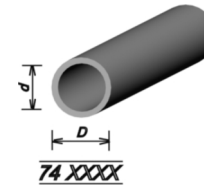

Profily medzikružného prierezu

Číslo profilu	Rozmer D / d	Číslo profilu	Rozmer D / d
7402.503.5/XX0000	3,5 / 2,5	741618/XX0000	18 / 16
740305/XX0000	5 / 3	741622/XX0000	22 / 16
740307/XX0000	7 / 3	742022/XX0000	22 / 20
740325/XX0000	25 / 3	742223/XX0000	23 / 22
7403.505.5/XX0000	5,5 / 3,5	742228/XX0000	28 / 22
740406/XX0000	6 / 4	742325/XX0000	25 / 23
740506/XX0000	6 / 5	742333/XX0000	33 / 23
740507/XX0000	7 / 5	742527/XX0000	27 / 25
740508/XX0000	8 / 5	742830/XX0000	30 / 28
740525/XX0000	25 / 5	742932/XX0000	32 / 29
740608/XX0000	8 / 6	743032/XX0000	32 / 30
740611/XX0000	11 / 6	743537/XX0000	37 / 35
740612/XX0000	12 / 6	743638/XX0000	38 / 36
740616/XX0000	16 / 6	744042/XX0000	42 / 40
740625/XX0000	25 / 6	744547/XX0000	47 / 45
740709/XX0000	9 / 7	745052/XX0000	52 / 50
740809/XX0000	9 / 8	745052/XX0000	52 / 50
740810/XX0000	10 / 8	745058/XX0001	58 / 50
740812/XX0000	12 / 8	745080/XX0001	80 / 50
740911/XX0000	11 / 9	745670/XX0001	70 / 56
741012/XX0000	12 / 10		
741014/XX0000	14 / 10		
741015/XX0000	15 / 10		
741116/XX0000	16 / 11		
741214/XX0000	14 / 12		
741218/XX0000	18 / 12		
741315/XX0000	15 / 13		
741318/XX0000	18 / 13		
741325/XX0000	25 / 13		
741416/XX0000	16 / 14		

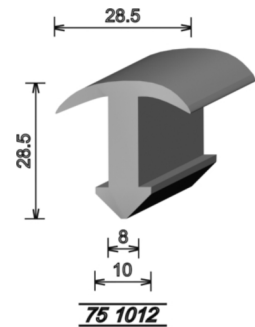
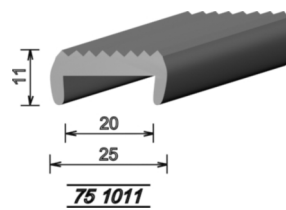
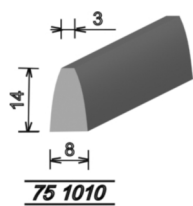
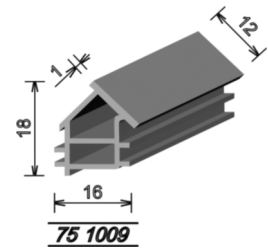
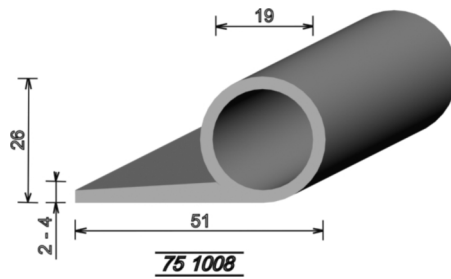
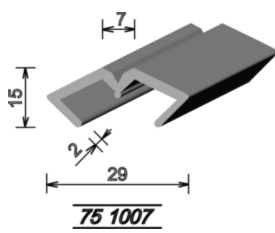
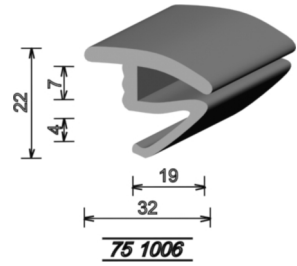
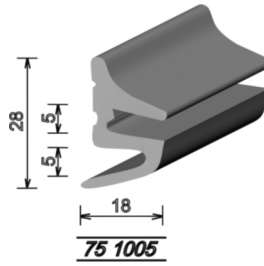
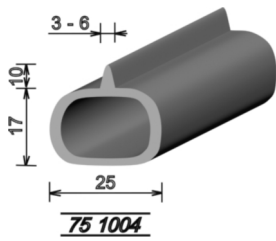
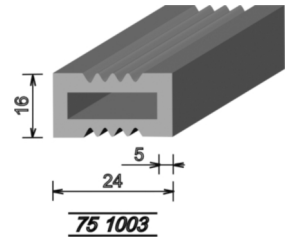
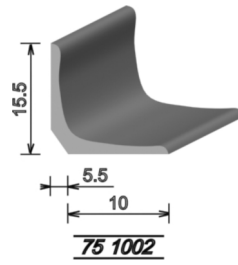
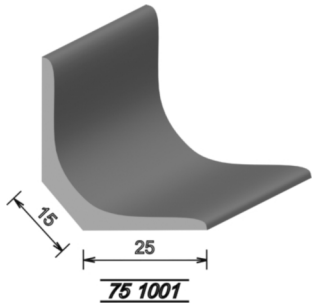

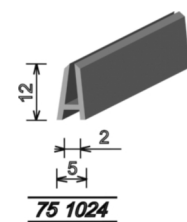
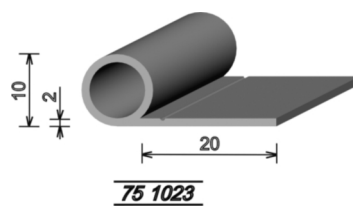
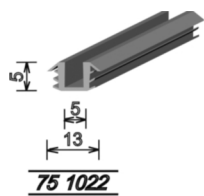
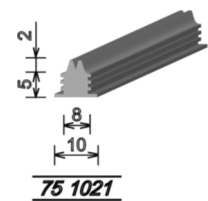
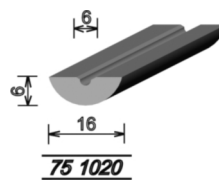
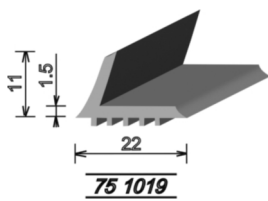
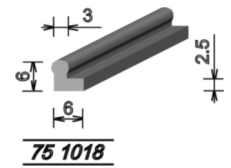
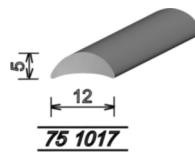
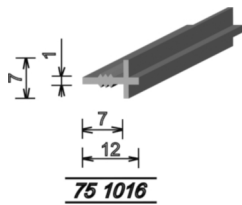
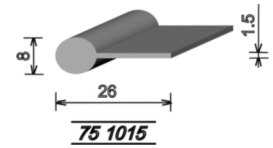
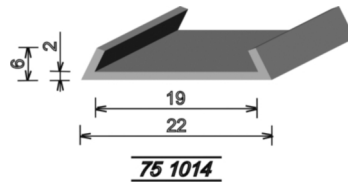
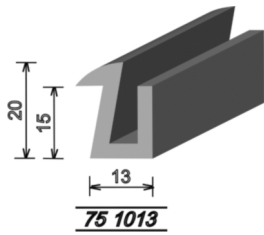

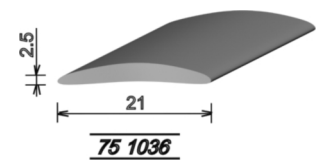
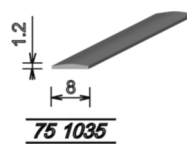
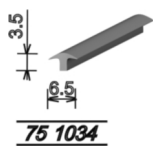
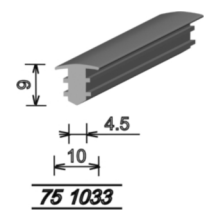
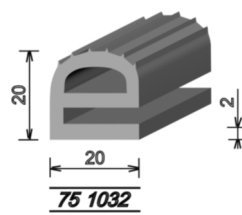
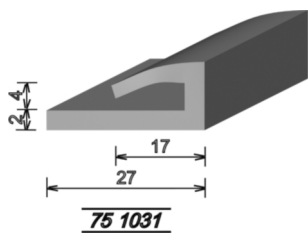
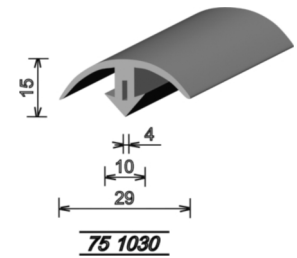
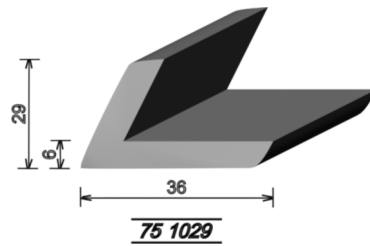
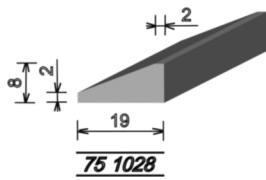
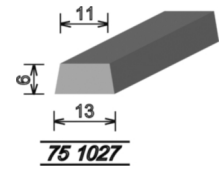
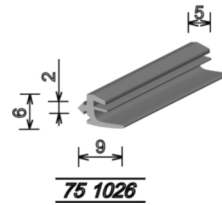
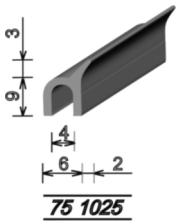

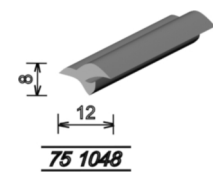
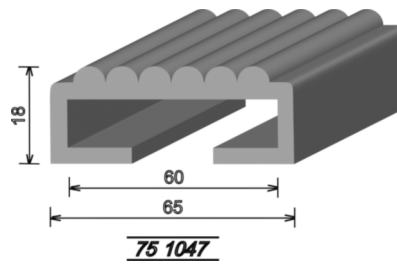
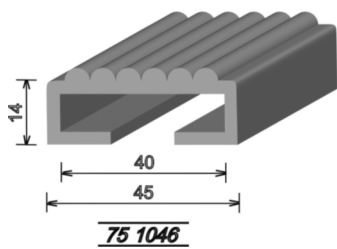
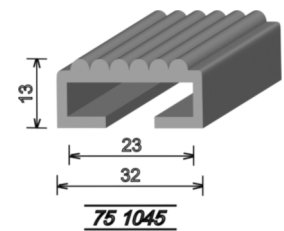
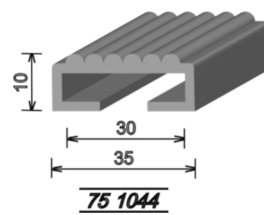
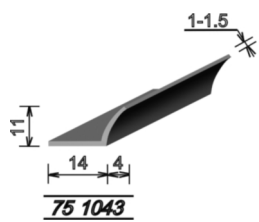
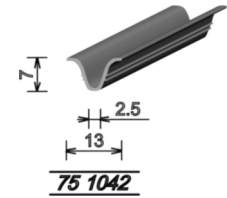
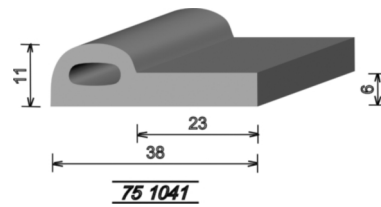
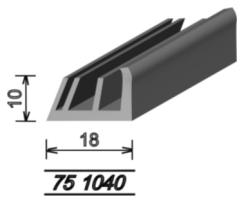
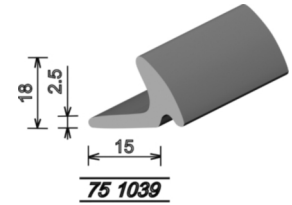
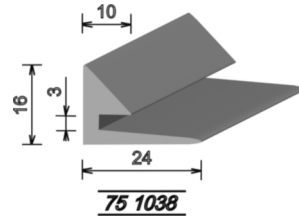
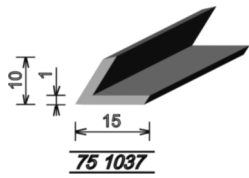

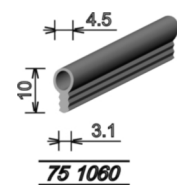
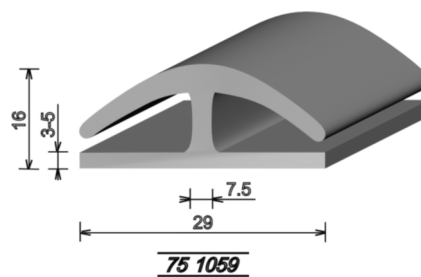
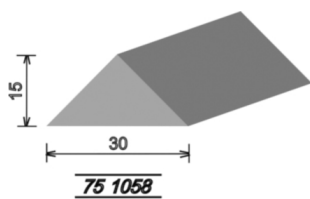
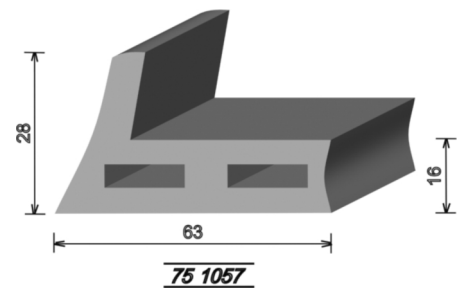
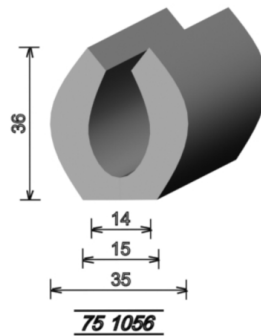
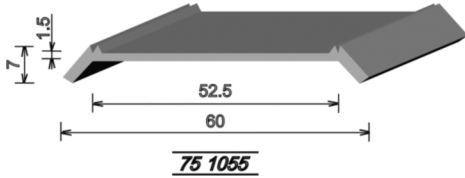
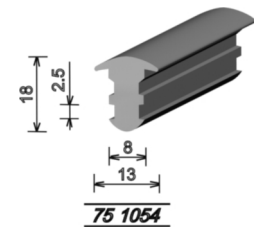
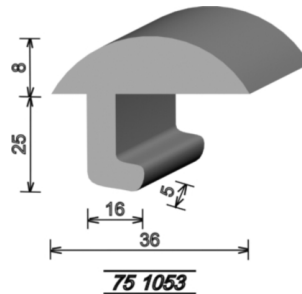
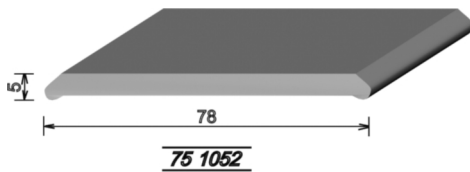
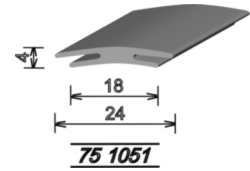
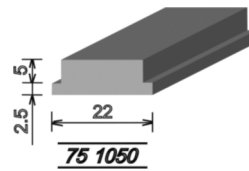
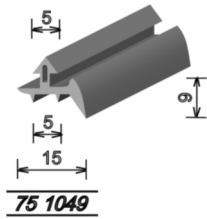

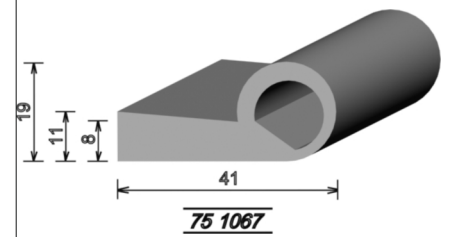
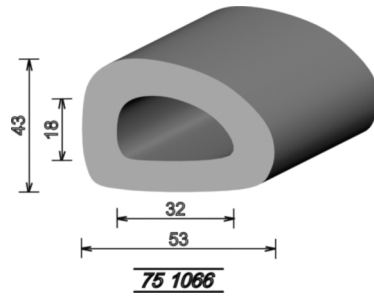
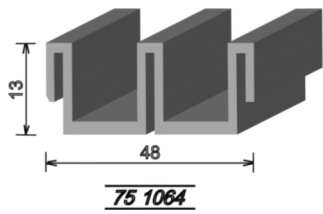
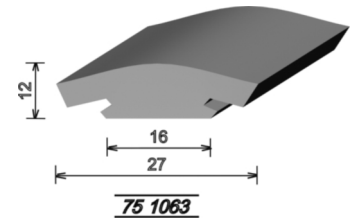
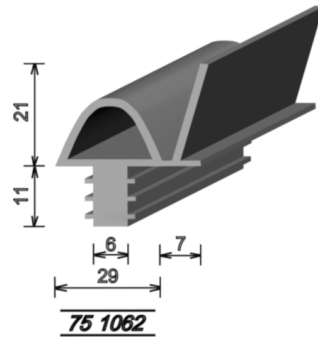
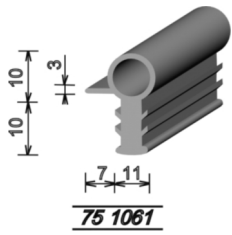

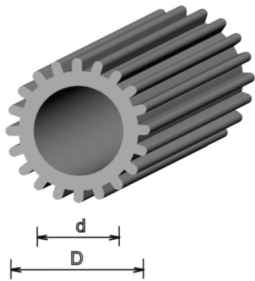

Hadica sieťková

Číslo profilov: 751068-XX

- jednotlivé rozmerové rady je možné nájsť v cenníku PVC profilov

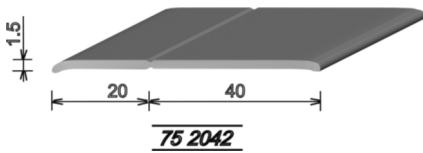
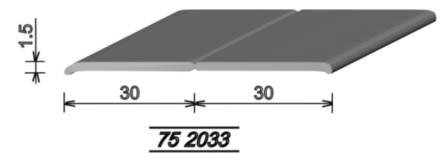
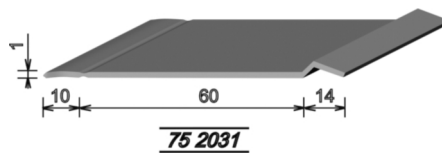
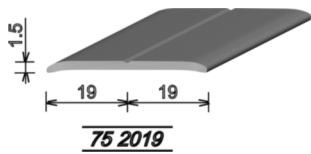

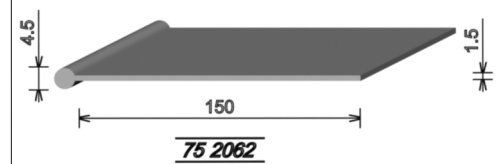
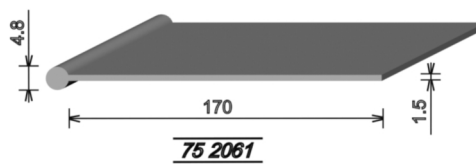
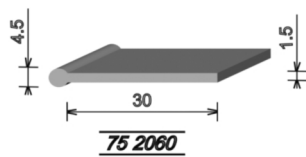
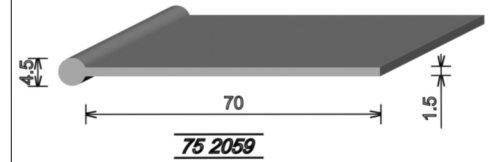
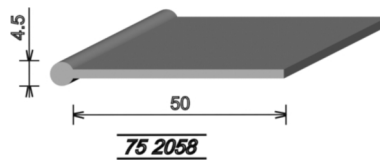
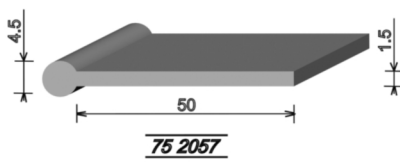
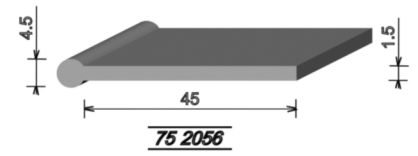
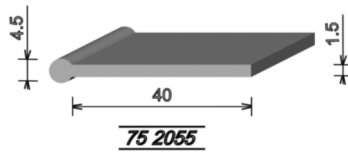
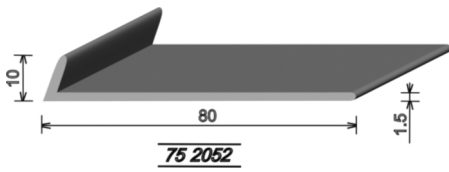
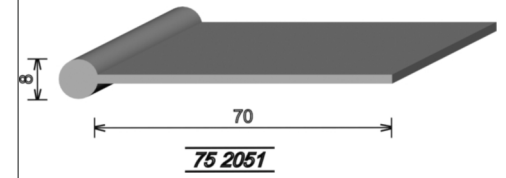
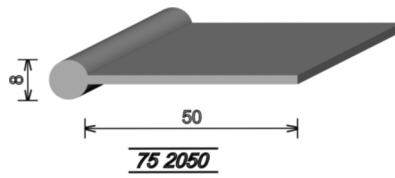
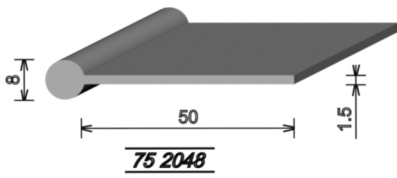

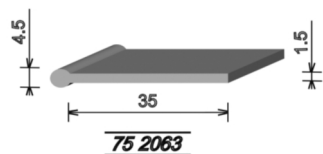

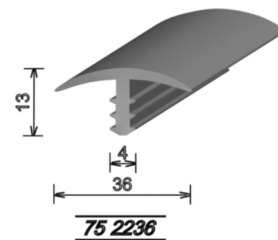
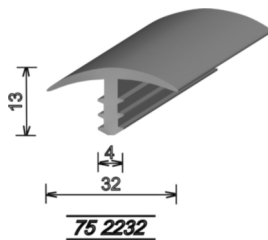
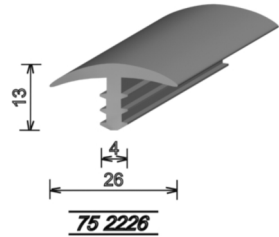
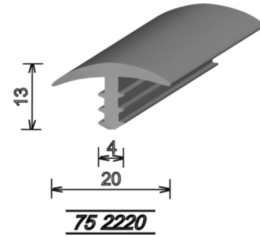
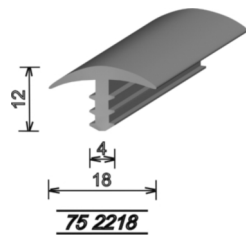
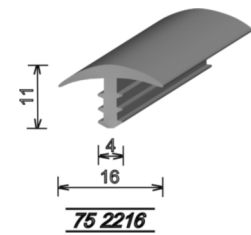
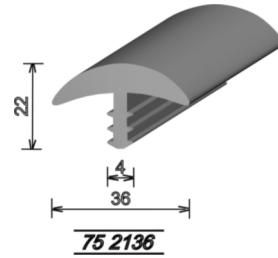
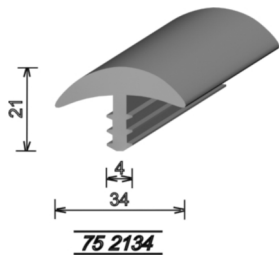
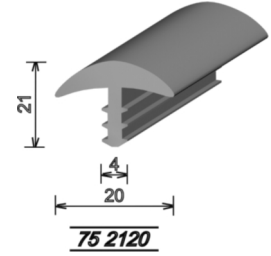
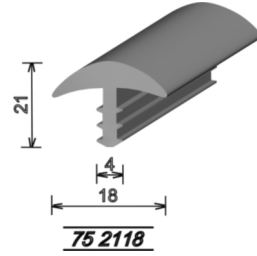
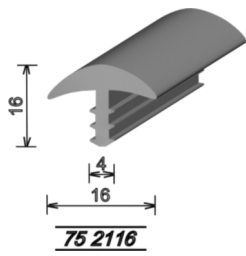

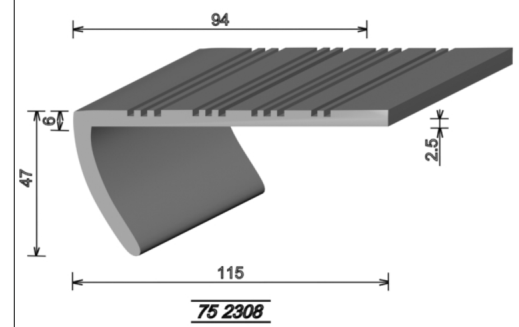
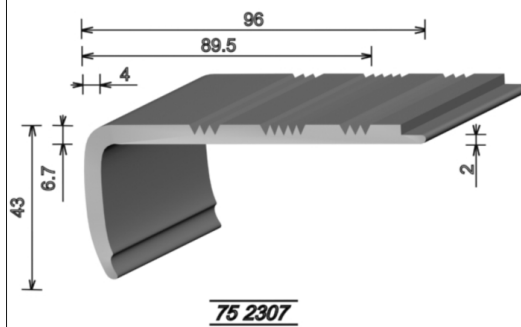
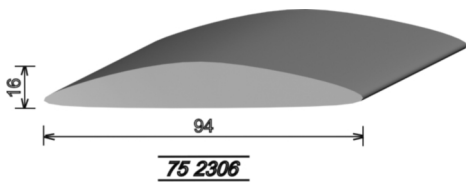
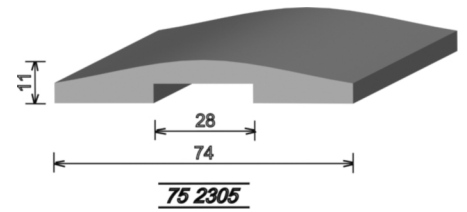
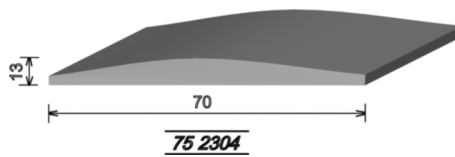
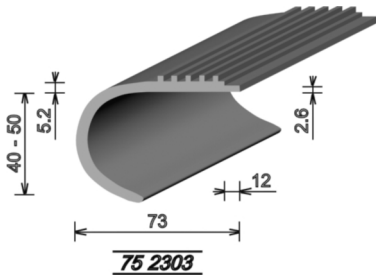
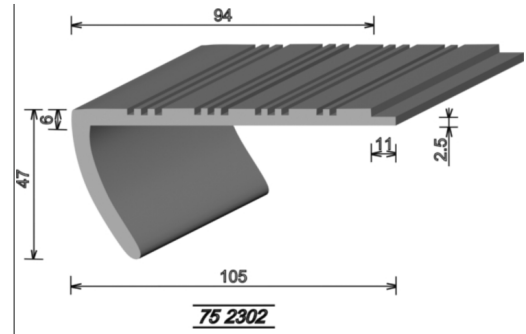
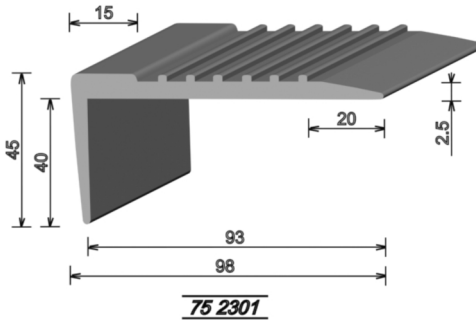
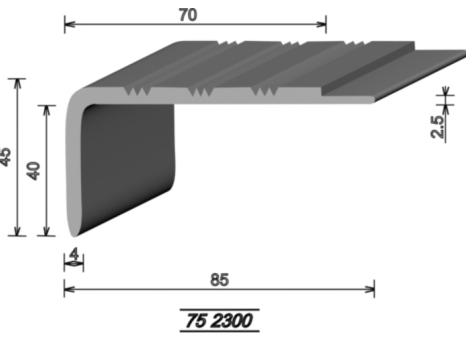

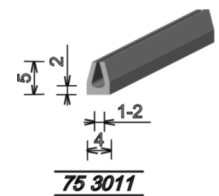
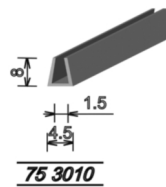
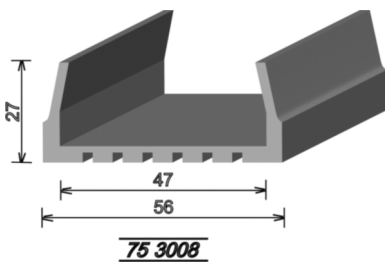
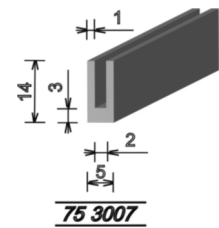
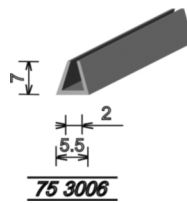
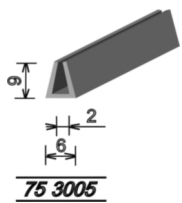
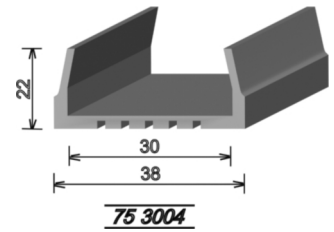
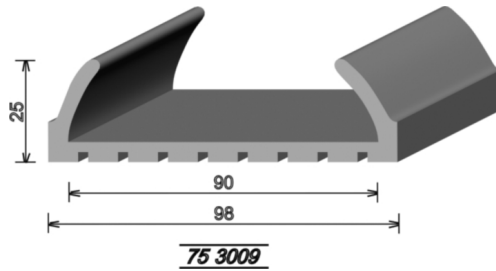
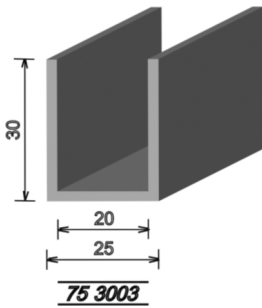
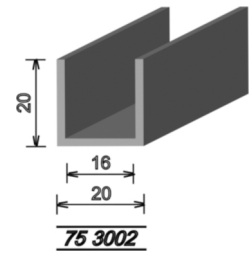
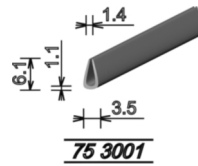
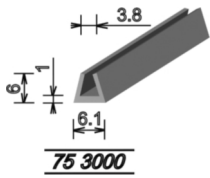

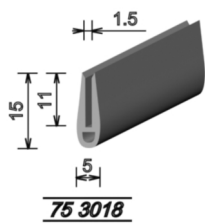
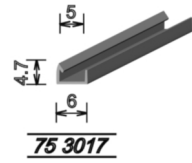
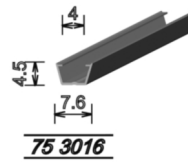
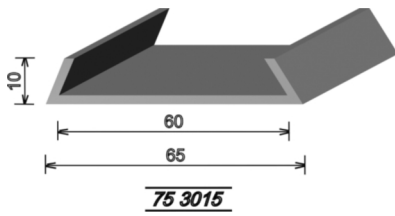
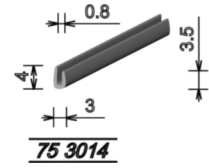
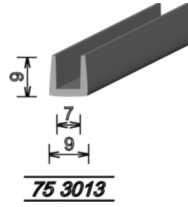
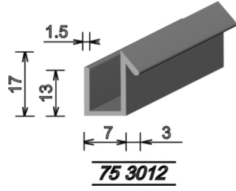

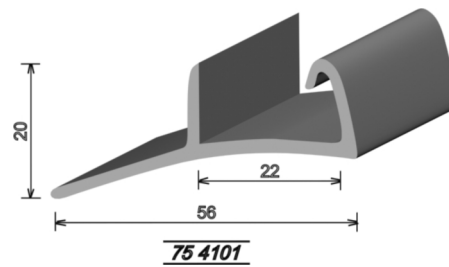
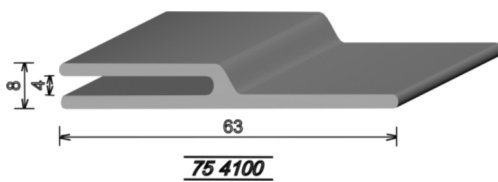
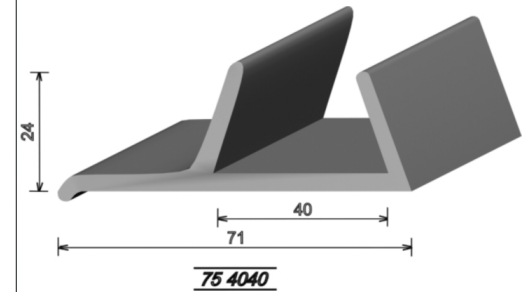
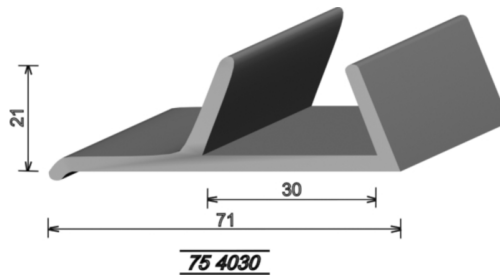
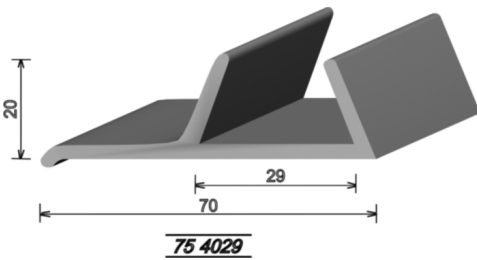
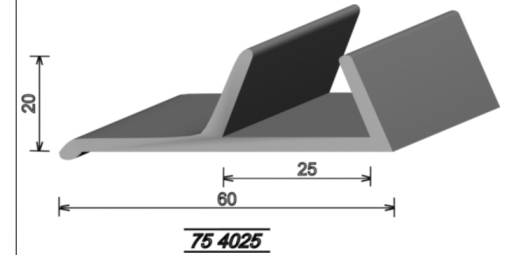
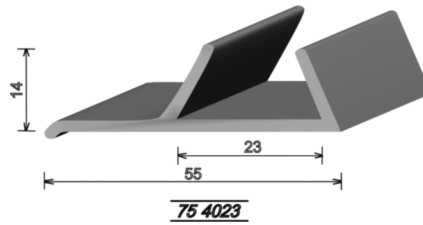
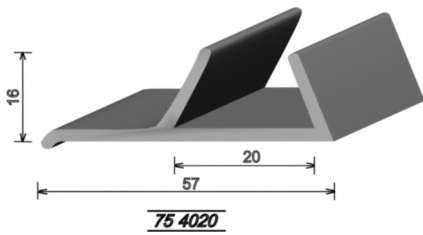
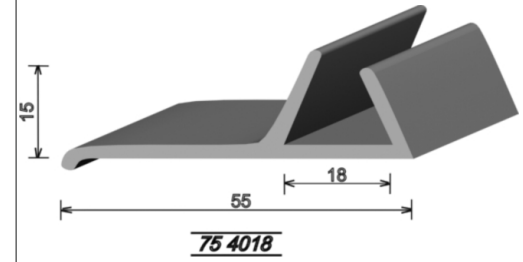
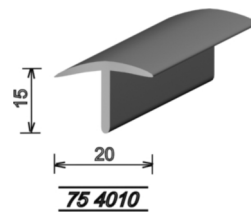
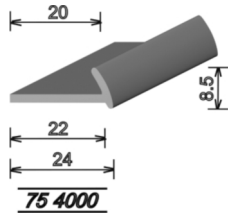

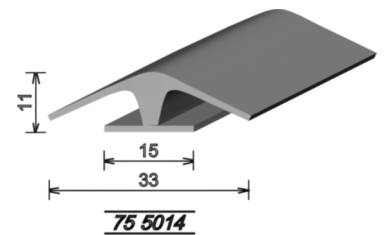
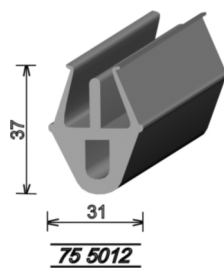
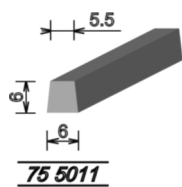
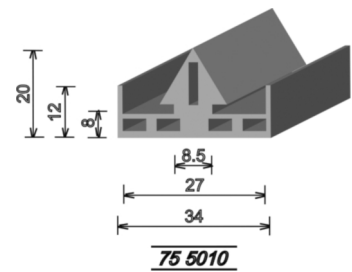
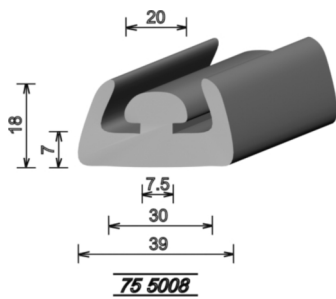
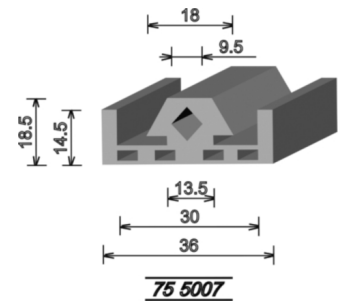
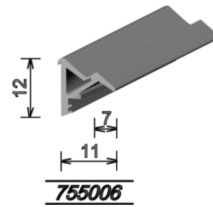
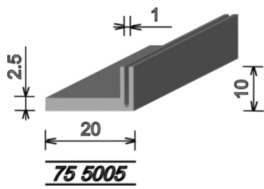
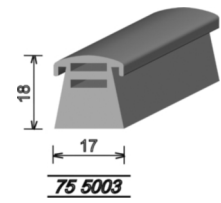
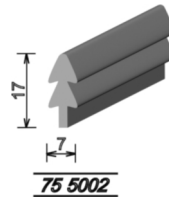
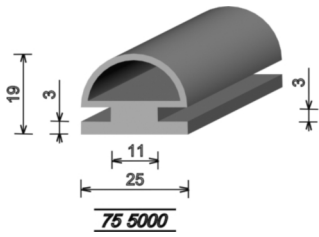

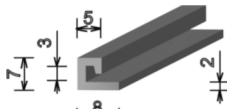

75 5015

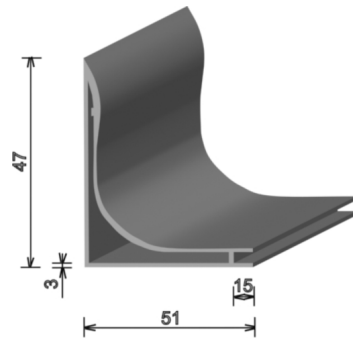

75 5016

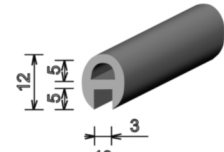

75 5017

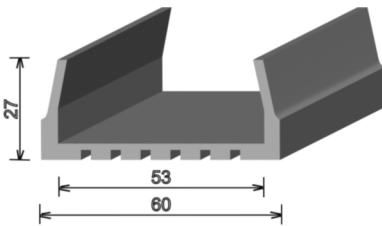

75 5018

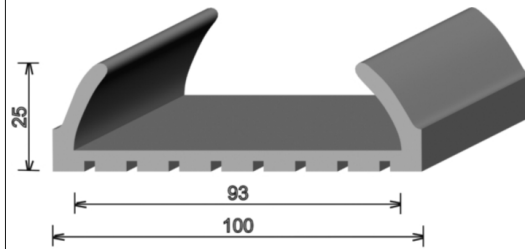

75 5019

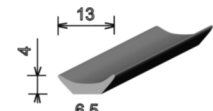

75 5020

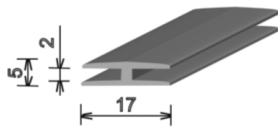

75 5021

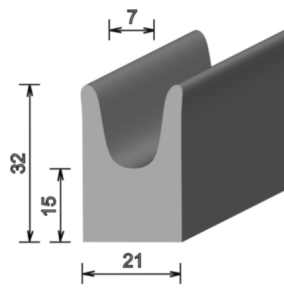

75 5022

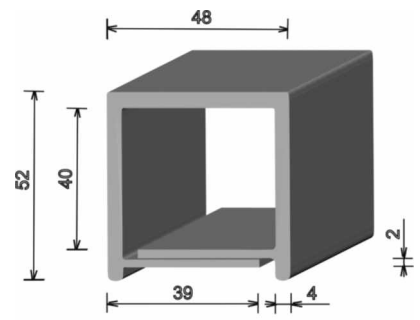

75 5023

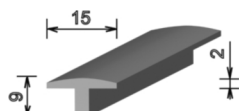

75 5024



75 5025

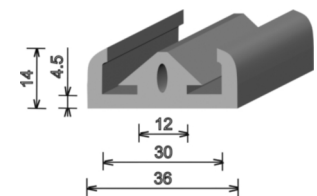

75 5026

